



Espacenet

**Общедоступная патентная база
данных Европейского патентного
ведомства**

<http://worldwide.espacenet.com>

Создана в 1998г



Титульная страница сайта ЕПВ

<http://www.epo.org>

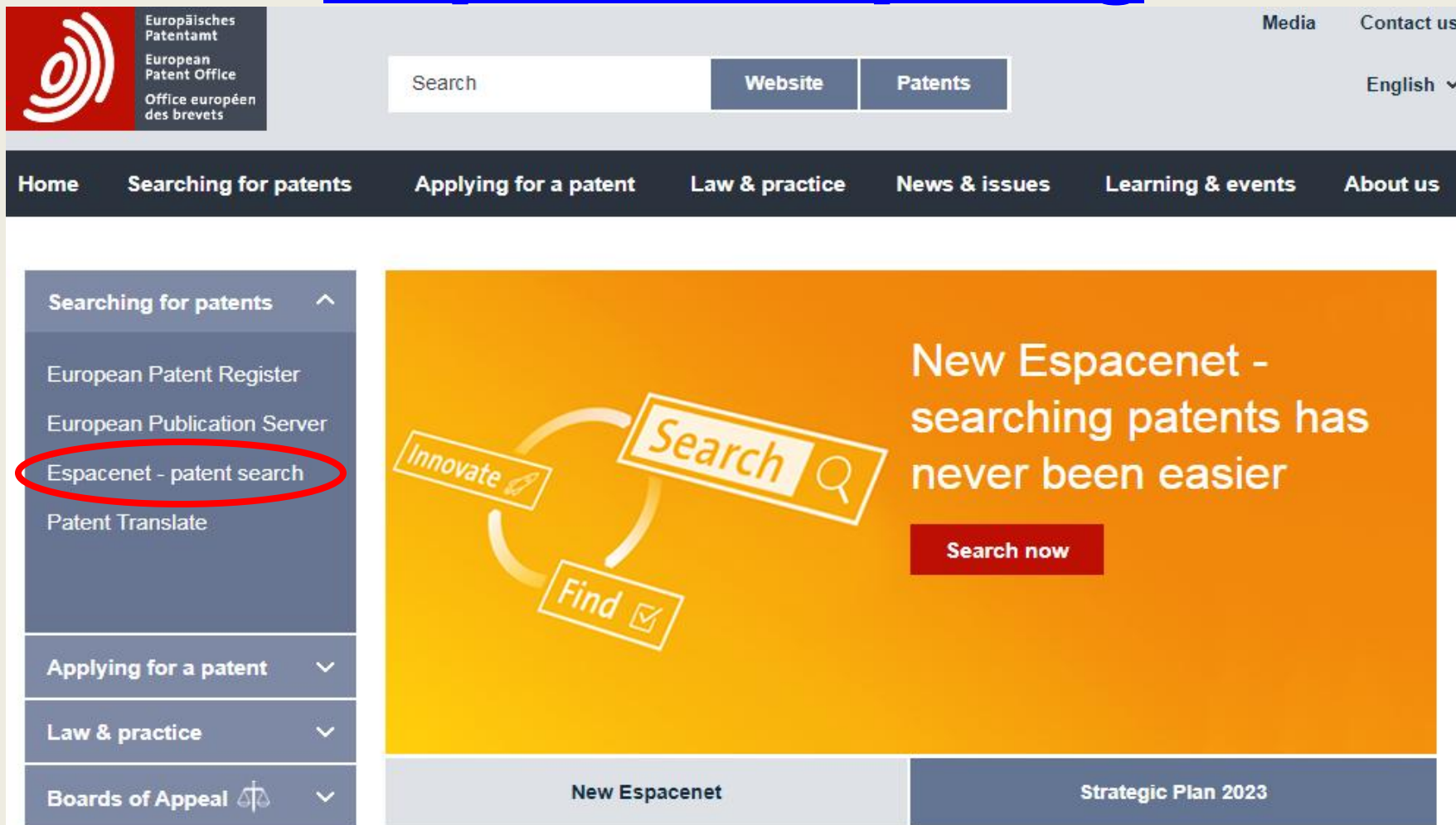

The screenshot shows the top navigation bar of the EPO website. On the left is the EPO logo and the text 'Europäisches Patentamt', 'European Patent Office', and 'Office européen des brevets'. On the right are links for 'Media' and 'Contact us', and a language dropdown set to 'English'. Below this is a dark navigation bar with links: 'Home', 'Searching for patents', 'Applying for a patent', 'Law & practice', 'News & issues', 'Learning & events', and 'About us'. The main content area features a large orange banner for 'New Espacenet - searching patents has never been easier' with a 'Search now' button. On the left, a sidebar menu is open, showing 'Searching for patents' with a sub-menu where 'Espacenet - patent search' is circled in red. Other sidebar items include 'European Patent Register', 'European Publication Server', 'Patent Translate', 'Applying for a patent', 'Law & practice', and 'Boards of Appeal'. At the bottom, there are two buttons: 'New Espacenet' and 'Strategic Plan 2023'.

Europäisches Patentamt
European Patent Office
Office européen des brevets

Media Contact us

Search Website Patents

English ▾

Home Searching for patents Applying for a patent Law & practice News & issues Learning & events About us

Searching for patents ^

European Patent Register

European Publication Server

Espacenet - patent search

Patent Translate

Applying for a patent ▾

Law & practice ▾

Boards of Appeal ⚖️ ▾

Innovate Search Find

New Espacenet -
searching patents has
never been easier

Search now

New Espacenet Strategic Plan 2023



Переход в Espacenet

- Home
- Searching for patents
- Applying for a patent
- Law & practice
- News & issues
- Learn

Home > Searching for patents > Technical information > Espacenet - patent search

Espacenet - patent search

Global Patent Index (GPI)

European Publication Server

Searching Asian documents

EP full-text search

Espacenet patent search



With its worldwide coverage and search features, Espacenet offers free access to information about inventions and technical developments from 1782 to today.

[Open Espacenet](#)

[> Open classic Espacenet](#)



Стартовая страница Espacenet



Europäisches Patentamt
European Patent Office
Office européen des brevets

Espacenet
Patent search

Deutsch English Français
Contact

Change country

About Espacenet Other EPO online services

Search Result list My patents list (0) Query history Settings Help

Smart search

Advanced search

Classification search

Espacenet: free access to over 110 million patents

Smart search:

Try the new Espacenet beta

[Tell us what you think.](#)

Albania	Arabpat
Austria	Belgium
Bulgaria	China
Croatia	Cyprus
Czech Republic	Denmark
EAPO	Estonia
Finland	Greece
Hungary	Iceland
Ireland	Italy
Japan	Korea
Latipat	Latvia
Lithuania	Luxembourg
Netherlands	North Macedonia
Norway	Poland
Portugal	Republic of Moldova
Romania	Russia
San Marino	Serbia
Slovakia	Slovenia
Spain	Sweden
Turkey	



Наполнение Espasenet

- Более 110 млн. документов из более чем 100 стран и международных организаций
- Основа – минимум РСТ (~ 1/3)
- [Help / The worldwide patent database](#)

Availability of the PCT minimum documentation in the worldwide database

Country	Facsimiles from	Abstracts from	Cooperative Patent Classification (CPC)
CH	1888, from CH1 onwards	1970	1888
DE	1877, from DE1 onwards	1970	1877, from DE1 onwards
EP	1978, from EP1 onwards	1978	1978
FR	1900	1970	1902
GB	1859	1893	1859
US	1836, from US1 onwards	1970	1836, from US1 onwards
WO	1978	1978	1978

Latest updates to the database

You will find up-to-date information on the EPO website under [Latest Bibliographic coverage](#) and [Latest full-text coverage](#). Both lists are updated daily.

Updates to the database

The EPO's databases are updated daily. Data is added to the database as soon as possible after it is received from the national patent granting authorities. For more information on the data content of the database, see [Information on EPO data](#) on the [EPO website](#).



Непатентная литература

- В Espasenet включена и непатентная литература (НПЛ или NPL), **но** только те ссылки на НПЛ, которые были:
 - 1) проклассифицированы экспертами ЕПВ по СРС и/или
 - 2) процитированы в их отчетах о поиске
- Ссылкам на НПЛ присвоены номера с двубуквенным кодом **XP**, например: XP1 или XP000123456
- XP могут быть найдены только по СРС или номеру
- Поиск документов XP по автору и словам невозможен
- Нельзя ограничить поиск только НПЛ (т.е. по коду XP)



Поисковые массивы в Espacenet

- **Worldwide** - вся вышеупомянутая коллекция патентных документов разных стран мира (в очень разных объемах представления информации по странам).
- **Worldwide EN** – коллекция патентных документов, опубликованных на английском языке, предоставляющая возможность полнотекстового поиска на английском языке. Коллекция отобрана из документов БД Worldwide, имеющих тексты на английском языке.
- **Worldwide FR** - коллекция патентных документов, опубликованных на французском языке, предоставляющая возможность полнотекстового поиска на французском языке. Коллекция отобрана из документов БД Worldwide, имеющих тексты на французском языке.
- **Worldwide DE** - коллекция патентных документов, опубликованных на немецком языке, предоставляющая возможность полнотекстового поиска на немецком языке. Коллекция отобрана из документов БД Worldwide, имеющих тексты на немецком языке.



Основные поисковые ограничения

- Документы, не входящие в «минимум РСТ», часто не имеют ни реферата, ни даже полной библиографии (см. Help).
- В массиве “Worldwide” – поиск только по рефератам и библиографии документов
- Ключевые слова, вводимые для поиска в поле реферат, должны быть только на английском языке
- Имена изобретателей и имена или наименования заявителей тоже должны вводиться на английском
- Левостороннее усечение и подстановки в середине слов в системе невозможны
- **Примечание:** как и во всех БД, нельзя (и нет смысла) использовать термины, определяемые, как «стоп - слова» (FOR, WITH, THE, BUT, AND, OF, ANY и т.п.)



Достоинства Espasenet

- Самая большая коллекция патентных документов стран мира
- Ежедневное пополнение
- И список результатов, и отдельные документы можно экспортировать из БД, сохранять и распечатывать, не распечатывая при этом детали интерфейса
- 3 вида поиска, в т.ч. по классификации СПК
- «Smart search» и полнотекстовый поиск по «одноязычным» массивам документов (EN, FR, DE) приблизили поисковые возможности системы к возможностям лучших БД .
- Регистр букв (строчные или заглавные) может быть любым, при этом будут найдены эти слова, записанные как строчными, так и заглавными буквами



Advanced search (Расширенный поиск)

- Smart search
- Advanced search**
- Classification search

Quick help

- [How many search terms can I enter per field?](#)
- [How do I enter words from the title or abstract?](#)
- [How do I enter words from the description or claims?](#)
- [Can I use truncation/wildcards?](#)
- [How do I enter publication, application, priority and NPL reference numbers?](#)
- [How do I enter the names of persons and organisations?](#)
- [What is the difference between the IPC and the CPC?](#)
- [What formats can I use for the publication date?](#)
- [How do I enter a date range for a publication date search?](#)
- [Can I save my query?](#)

Related links

Select the collection you want to search in

Enter your search terms - CTRL-ENTER expands the field you are in

Enter keywords in English

Title:

Title or abstract:

Enter numbers with or without country code

Publication number:

Application number:

Priority number:

Enter one or more dates or date ranges

Publication date:

Enter name of one or more persons/organisations

Applicant(s):

Inventor(s):

Enter one or more classification symbols

CPC

IPC

Clear Search



Ограничения в Advanced search

- В одно поисковое поле может быть введено не более 10 терминов
- Поисковых полей – только 10
- Для составления всего запроса может быть использовано не более 20 поисковых терминов с 19 логическими операторами.
- По умолчанию поисковые поля между собой соединяются только оператором **AND** («И»)
- При поиске в полнотекстовых массивах Worldwide EN (FR, DE) вместо двух полей “Title” и “Title or abstract” появляется одно поле – «Keyword(s) in title, abstract and full text» («Ключевые слова в названии, реферате и полном тексте»).



Логические операторы

- Три логических (булевых) оператора – **AND** (И), **OR** (ИЛИ) и **NOT** (НЕ)
[кроме Smart search, где добавлены операторы близости и сравнения]
- Оператором по умолчанию в текстовых полях и классификациях является оператор **AND**
- Все номера (заявок, приоритетных заявок и патентов) и даты публикации – по умолчанию объединяются оператором **OR** (ИЛИ)
- При поиске в поле «Дата публикации» не вводятся никакие логические операторы, хотя логика соединения дат соответствует логике **OR** (ИЛИ)

- Только в текстовых полях в конце слов
- Подстановки «?» и «#»
(не менее 2-х букв в начале слова)
- Усечение *
(не менее 3-х букв в начале слова)



Усечения и подстановки

?

1 или 0 символов `ozon?` `ozon` `ozone`

#

1 символ `ozon#` `ozone`

*

любое количество символов `ozon*` `ozone` `ozonation`
`ozonide` `ozonize` `ozonized` `ozonometer`



Запись номеров публикаций и дат

- Формат записи регистрационных номеров заявок (в том числе приоритетных) - **ССГГГГnnnnnnnn**, где **СС** - двубуквенный код страны, **ГГГГ** - год, **nnnnnnnn** – шестизначный или семизначный регистрационный номер заявки (если знаков в номере заявки меньше семи, то лучше дополнять его предшествующими нулями до 7). Номер записывается без пробелов. Например, GB1995**000**8026.
- Формат ввода номера публикации: **ССnnnnnnnnnn**, где **СС** - двубуквенный код страны, **nnnnnnnnnn** - номер, состоящий из различного (от 1 до 10) количества знаков. Не следует делать пробел между двубуквенным кодом и цифрами.

Пример: **FR4231348**, **CH218103**.

- Формат ввода дат: **ГГГГ** или **ГГГГММ** или **ГГГГММДД**. Допускается **ДД/ММ/ГГГГ**.



Диапазон дат

Поиск документов внутри задаваемого диапазона дат осуществляется указанием начальной и конечной дат интервала. Задать интервал дат можно несколькими способами:

- даты, разделенные пробелом, например "2000 2001", как в кавычках, так и без них;
- даты, разделенные двоеточием, например: 2000:2001 (только в Advanced search);
- даты, разделенные запятой, например **2000,2001**;

Во всех этих случаях система будет искать публикации, осуществленные между **01.01.2000** и **31.12.2001**, включая эти даты.



Запись рубрик МПК и СРС

- **H04N7/173** - без пробелов
- В **МПК** на любом уровне действует «автосечение» (ставить * **нельзя**) :
H, B62, B62J, A47D15, B60N2/28, A47D15/00
- Но в **СРС** при поиске по более дробным рубрикам, чем подгруппа МПК, для усечения можно ставить знак * : *A47D15/00**
или использовать оператор */low*



Формат имен и названий

- **Стандартный**: сначала фамилия (Surname или Last name), а затем имя (First name).
- Если неясно, изобретателю или заявителю принадлежит это имя, используйте для поиска **Smart**
- Названия **фирм** не стандартизированы. Пробуйте все возможные варианты написания названий, их частей, транслитерации, аббревиатур и т.п.



Поиск по странам

- Для выбора документов какой-либо страны достаточно ввести в соответствующее «номерное» поле её двубуквенный код
- Например, для поиска заявок РСТ, приоритетными к которым являются заявки РФ, достаточно ввести запрос:

Enter numbers with or without country code

Publication number:	<input type="text" value="WO2008014520"/>
Application number:	<input type="text" value="DE201310112935"/>
Priority number:	<input type="text" value="WO1995US15925"/>

The form shows three rows of input fields. The first row is for 'Publication number' with the value 'WO2008014520'. The second row is for 'Application number' with the value 'DE201310112935'. The third row is for 'Priority number' with the value 'WO1995US15925'. In the second and third rows, the labels 'Application number:' and 'Priority number:' are circled in red. Below the 'Application number' input, the letters 'WO' are circled in red. Below the 'Priority number' input, the letters 'RU' are circled in red. On the left side of the form, there are small icons: a lowercase 'a' next to the first row, and a '+' sign in a square box next to the second and third rows.



Постоянное горизонтальное меню

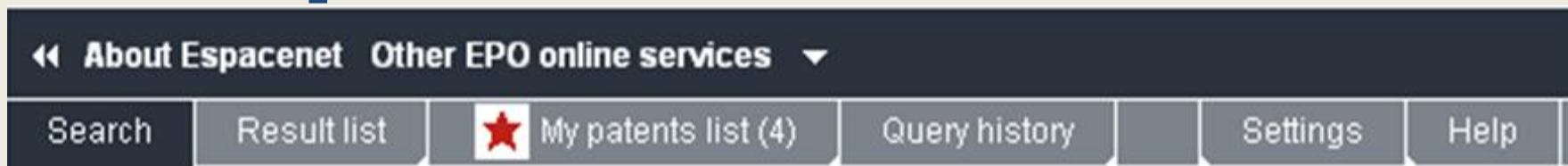

- **Result list** – На рабочем компьютере сохраняется список результатов последнего поиска
- **My patent list** – Из списка результатов можно отобразить документы (до 100 документов) и хранить их в «Моем списке» до года
- **Query history** – «История запросов», в которой хранятся последние 10, 25 или 50 (по выбору) запросов, [если](#) включена соответствующая установка (**Settings**). Из «Истории запросов» ненужные запросы можно удалять.
- **Settings** – позволяет включить/выключить возможность сохранения запросов (с выбором их числа), всплывающие определения рубрик классификаций и подсветку поисковых терминов.



Список результатов > 500

[About Espacenet](#) [Other EPO online services](#)

[Search](#) [Result list](#) [★ My patents list \(1\)](#) [Query history](#) [Settings](#) [Help](#)

[Refine search](#) → [Results page](#)

Smart search
 Advanced search
 Classification search

Quick help

- [Can I subscribe to an RSS feed of the result list?](#)
- [What does the RSS reader do with the result list?](#)
- [Can I export my result list?](#)
- [What happens if I click on "Download covers"?](#)
- [Why is the number of results sometimes only approximate?](#)
- [Why is the list limited to 500 results?](#)
- [Can I deactivate the highlighting?](#)
- [Why is it that certain documents are sometimes not displayed in the result list?](#)
- [Can I sort the result list?](#)
- [What happens if I click on the star icon?](#)
- [What are XP documents?](#)
- [Can I save my query?](#)

Related links

Result list

Select all (0/25) Compact Export (CSV | XLS) Download covers Print

Approximately **1,014** results found in the Worldwide database for: **computer bicycle** in the title or abstract
 Only the first **500** results are displayed.

Results are sorted by **date of upload in database**

1. **Tension-optimized method for manufacturing a rim**

★ Inventor:	Applicant:	CPC:	IPC:	Publication info:	Priority date:
LESCHIK THOMAS [DE] WISLER ERHARD [DE]	CARBOFIBRETEC GMBH [DE]	B29C2053/8025 B29C53/588 B29C53/60 (+5)	B29C70/00 B60B21/00 B60B5/02	TW201803742 (A) 2018-02-01	2016-07-18

2. **Gauge Type Bicycle Computer**

★ Inventor:	Applicant:	CPC:	IPC:	Publication info:	Priority date:
BLEECKER JULIAN [US] NEWMAN JOHN-RHYS [US]	OMATA INC [US]	B62J2099/0013 B62J99/00 G01S19/19 (+1)	B62J99/00 G01S19/19 G01S19/52	US2018099718 (A1) 2018-04-12	2016-10-12

3. **Locomotive electric control device**

★ Inventor:	Applicant:	CPC:	IPC:	Publication info:	Priority date:
LIU YINGHENG YAN GUIJUN (+3)	ANSHAN KUANGTONG ENGINEERING TECH CO LTD		B61C17/00	CN206871068 (U) 2018-01-12	2017-06-30

4. **Energy -concerning and environment -protective bicycle electricity generation interaction entertainment device**

★ Inventor:	Applicant:	CPC:	IPC:	Publication info:	Priority date:
HE WEI SUN SHAN (+1)	NANJING ASIPANA SMART SPACE BUILDING CO LTD		A63B22/06 F03G5/02 H01N9/31	CN206910674 (U) 2018-01-23	2017-06-15



Использование опции «Download covers»

Result list | **★ My patents list (6)** | Query history | Settings | Help

Results page 1

Espacenet verification

Please enter the digits that can be read in the image below:



[Close this window](#)

Result list

Select all

Approximate results (ta = solar engine)

Sort by [U]

1. Vacuum coated soda

★ Inventor:

2. Solar powered voltage driver-stage for operating solar engine, has solar module whose output voltage is limited by diode or transistor, where stage switches its output voltage to zero during low voltage

★ Inventor: Applicant: EC: IPC: Publication info:

BEHNKE WOLFGANG	H01L31/02H2B	H01L31/02	H02N6/00	DE202005014831 (U1)
MICHAEL [DE]	Y02E10/50	H02J7/35	H02J7/35 (+1)	2005-11-17

3. Solar light system for outdoor light fixture has brightness sensor for controlling the brightness and accumulator



Загруженный файл первых страниц списка

Esipacenet+search+results_091220151408.pdf - Adobe Reader

Файл Редактирование Просмотр Документ Инструменты Окно Справка

1 / 26 50,1% Найти

Закладки

- Cover sheet
- DE202012103998 (U1)
- DE202012103781 (U1)
- DE202012103775 (U1)
- DE202012103754 (U1)
- DE202012103599 (U1)
- DE202012103550 (U1)
- DE202012103549 (U1)
- DE202012103276 (U1)
- DE202012102775 (U1)
- DE202012102773 (U1)
- DE202012102693 (U1)

Europäisches Patentamt
European Patent Office
Office européen des brevets

Espacenet search results on 09-12-2015 14:08

Approximately 6,485 results found in the Worldwide database for:
DE as the publication number AND 201210 as the publication date
Displaying selected publications

Publication	Title	Page
DE202012103998 (U1)	Berührungskonsole und eine diese anwe...	2
DE202012103781 (U1)	Mopp mit eigener Beleuchtungsfunktion	3
DE202012103775 (U1)	Luftpumpenförmiges Steuergerät für El...	4
DE202012103754 (U1)	Klebeband, insbesondere Wickelband zu...	5
DE202012103599 (U1)	Beutel zum Einsetzen in einen zur Sch...	6
DE202012103550 (U1)	Scheibenwischer	7
DE202012103549 (U1)	nte	8
DE202012103276 (U1)	Universalstütze	9
DE202012102775 (U1)	Halterung einer Federleiste	10
DE202012102773 (U1)	Befüllbarer Gegenstand	11
DE202012102893 (U1)	Automatisches Sensorkontrollfeld	12
DE202012101262 (U1)	Verschlusseinrichtung sowie Fahrzeug...	13
DE202012009765 (U1)	Vertikale Seilzugvorrichtung für Nied...	14
DE202012009764 (U1)	Deckenleuchte mit homogen leuchtendem...	15
DE202012009763 (U1)	Horizontale Seilzugvorrichtung für Ho...	16
DE202012009690 (U1)	Modulare elektrische Vorrichtung	17
DE202012009689 (U1)	Modulare elektrische Vorrichtung	18
DE202012009685 (U1)	Klappbox	19
DE202012009670 (U1)	NFC-Tag und NFC-System	20
DE202012009658 (U1)	Sitzkissen zum dynamischen Sitzen	21
DE202012009651 (U1)	Sitzringkissen zum dynamischen Sitzen	22



Список результатов < 500

[Refine search](#) → Results page 1

- Smart search
- Advanced search
- Classification search

Quick help

- [Can I subscribe to an RSS feed of the result list?](#)
- [What does the RSS reader do with the result list?](#)
- [Can I export my result list?](#)
- [What happens if I click on "Download covers"?](#)
- [Why is the number of results sometimes only approximate?](#)
- [Why is the list limited to 500 results?](#)
- [Can I deactivate the highlighting?](#)
- [Why is it that certain documents are sometimes not displayed in the result list?](#)
- [Can I sort the result list?](#)
- [What happens if I click on the star icon?](#)
- [What are XP documents?](#)
- [Can I save my query?](#)

Related links

Result list

Select all (0/25)
 Compact
 Export (CSV | XLS)

Approximately 385 results found in the Worldwide database for:
A01B1/04/low or A01B1/10/low as the Cooperative Patent Classification

Sort by	Sort order	Sort
<input type="checkbox"/> 1. Publication date	Descending	<input type="button" value="Sort"/>
<input type="checkbox"/> 1. Priority date		
<input type="checkbox"/> 1. Inventor		
<input type="checkbox"/> 1. Applicant		
<input type="checkbox"/> 1. CPC		
<input type="checkbox"/> 1. IPC		
<input type="checkbox"/> 1. Publication info		
<input type="checkbox"/> 1. Priority date		
<input type="checkbox"/> 2. FARMING TOOLS		
<input type="checkbox"/> 2. Inventor		
<input type="checkbox"/> 2. Applicant		
<input type="checkbox"/> 2. CPC		
<input type="checkbox"/> 2. IPC		
<input type="checkbox"/> 2. Publication info		
<input type="checkbox"/> 2. Priority date		
<input type="checkbox"/> 3. A Horticultural Implement and a Garden Tool for Removal of Weed in a Tile System		
<input type="checkbox"/> 3. Inventor		
<input type="checkbox"/> 3. Applicant		
<input type="checkbox"/> 3. CPC		
<input type="checkbox"/> 3. IPC		
<input type="checkbox"/> 3. Publication info		
<input type="checkbox"/> 3. Priority date		



Работа со списком результатов

- В список найденных документов всегда включается не более **500** документов;
- Для последующего анализа в «**My patent list**» может быть отобрано (нажатием на звёздочку в списке) до 100 документов, хранящихся в течение года;
- В закладке «**Result list**» (в основном горизонтальном меню) сохраняется список результатов последнего выполненного запроса.
- Опция "**Download Covers**" («Загрузить титульные страницы»)
- Представленная на экране часть списка результатов может быть экспортирована в формате Excel (CSV или XLS) файла в заданное место.

Работа с документом

Search Result list **★ My patents list (1)** Query history Settings Help

Refine search → Results page 2 → EP1703258 (A1)

EP1703258 (A1)

Bibliographic data
Description
Claims
Mosaics
Original document
Cited documents
Citing documents
INPADOC legal status
INPADOC patent family

Bibliographic data: EP1703258 (A1) — 2006-09-20

★ In my patents list Previous 27 / 52 Next EP Register Report data error Print

Bicycle computer

Page bookmark EP1703258 (A1) - Bicycle computer

Inventor(s): KORTENBREDE LUDGER [DE]; WISSMANN ANDREAS [DE]; STEINKAMP WINFRIED [DE]; WEWER FRANZ-JOSEF [DE] ±

Applicant(s): TRELOCK GMBH [DE] ±

Classification:
- international: **B62J99/00; G01C22/00**
- cooperative: **B62J99/00; G01C22/002; B62J2099/0013; B62J2099/0026**

Application number: EP20060001777 20060128 **Global Dossier**

Priority number(s): DE20051012791 20050319

Also published as: EP1703258 (B1) → AT555366 (T) DE102005012791 (A1)

- Quick help
- What is meant by high quality text as facsimile?
 - What does A1, A2, A3 and B stand for after a European publication number?
 - What happens if I click on "In my patents list"?
 - What happens if I click on the "Register" button?
 - Why are some sidebar options deactivated for certain documents?
 - How can I bookmark this page?
 - Why does a list of documents with the heading "Also published as" sometimes appear, and what are these documents?
 - Why do I sometimes find the

Abstract of EP1703258 (A1)

Translate this text into **patenttranslate** powered by EPO and Google

Bicycle computer (11) has a **computer** housing (10), which has a display unit. In the memory unit a coding is stored, which is assigned to the sensor (13). Through



Global Dossier

Просмотр переписки по заявке и сведений о делопроизводстве

Europäisches Patentamt
European Patent Office
Office européen des brevets

Deutsch English Français
Contact

European Patent Register

About European Patent Register Other EPO online services Register Alert login

Smart search Advanced search Help

P3100937
European procedure
About this file
Legal status
Federated register
Event history
Citations
Patent family
All documents

click help

Is it possible to download documents?
Is it possible to print a list of all the documents?
Can I sort the list of documents?
Is it possible to open one of the documents?
Can I open multiple documents in separate windows?
Is it possible to print a document?

aintenance news +
ews flashes +
elated links +

All documents: EP3100937 RSS: dossier

Refine search Selected documents Zip Archive Espacenet Submit observations Report error Print

All documents(17) Search

All documents(17)
Search / examination(17)
Received by EPO(8)
Sent by EPO(8)
Internal(1)

	Procedure	Number of pages
<input type="checkbox"/> of receipt of (electronically) transmitted priority document	Search / examination	1
<input type="checkbox"/> 12.12.2016 Reminder period for payment of examination fee/designation fee and correction of deficiencies in Written Opinion/amendment	Search / examination	2
<input type="checkbox"/> 08.12.2016 Priority document (electronically transmitted)	Search / examination	39
<input type="checkbox"/> 09.11.2016 Notification of forthcoming publication	Search / examination	2
<input type="checkbox"/> 10.10.2016 Communication regarding the transmission of the European search report	Search / examination	1
<input type="checkbox"/> 10.10.2016 European search opinion	Search / examination	1
<input type="checkbox"/> 10.10.2016 European search report	Search / examination	2
<input type="checkbox"/> 10.10.2016 Information on Search Strategy	Search / examination	1
<input type="checkbox"/> 30.09.2016 Modified abstract	Search / examination	1
<input type="checkbox"/> 16.06.2016 (Electronic) Receipt	Search / examination	1
<input type="checkbox"/> 16.06.2016 Letter accompanying subsequently filed items	Search / examination	2
<input type="checkbox"/> 03.06.2016 Abstract	Search / examination	1
<input type="checkbox"/> 03.06.2016 Claims	Search / examination	3
<input type="checkbox"/> 03.06.2016 Description	Search / examination	10
<input type="checkbox"/> 03.06.2016 Drawings	Search / examination	3
<input type="checkbox"/> 03.06.2016 Request for grant of a European patent	Search / examination	1



EP Register

Европейский патентный реестр

Bibliographic data: EP3100937 (A1) — 2016-12-07

★ In my patents list [EP Register](#) [Report data error](#)

Print

BICYCLE ILLUMINATION SYSTEM

Page bookmark [EP3100937 \(A1\) - BICYCLE ILLUMINATION SYSTEM](#)

Inventor(s): PETERSON MICHAEL [US]; PETERSON BRIAN [US]; PETERSON SEAN [US] ±

Applicant(s): PETERSON MICHAEL [US]; PETERSON BRIAN [US]; PETERSON SEAN [US] ±

Classification:
- international: **B62J6/00**
- cooperative: **B62J6/00; B62J6/003; B62K19/40**

Application number: EP20160020216 20160607 [Global Dossier](#)

Priority number(s): [US201514729875](#) [20150603](#)

Also published as: [US2016355227 \(A1\)](#) [US9610994 \(B2\)](#)

Abstract of EP3100937 (A1)

Translate this text into

Select language

patenttranslate powered by EPO and Google

A system for illuminating a bicycle having a frame comprising a plurality of tubular frame members (110) wherein each frame member has a plurality of orifices (120). The orifices (120) allow light rays to pass from inside each tubular frame member (110) to outside each tubular frame member (110). Bulbs (215) for emitting light are adapted to fit inside the tubular frame members (110) and are conductively coupled to a power source (225). The power source (225) is sized such that the power source (225) fits inside a vertically situated tubular frame member (205). A planar platform (230), having a length in one direction that is less than the inside cross sectional diameter of the vertically aligned tubular frame member (205), is sized so that the platform fits inside the vertical tubular frame member (205). The platform (230) supports the power source (225) and is positioned such that the power source (225) can be installed and

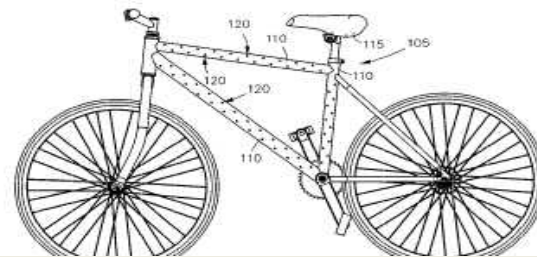



EP Register

Европейский патентный реестр

все стадии делопроизводства EP заявки

 Patentamt
 European Patent Office
 Office européen des brevets

European Patent Register
 Deutsch English Français
Contact

[Smart search](#)
[Advanced search](#)
[Help](#)

About this file: EP3100937

[Refine search](#)
[ST36](#)
[Espacenet](#)
[Submit observations](#)
[Report error](#)
[Print](#)

EP 3100937 - BICYCLE ILLUMINATION SYSTEM
[Right-click to bookmark this link]

Status	The application has been published <i>Status updated on 04.11.2016</i> <i>Database last updated on 31.05.2017</i>		
Most recent event	04.11.2016	Publication in section I.1 EP Bulletin	published on 07.12.2016 [2016/49]
Applicant(s)	For all designated states Peterson, Michael 13520 SW 136 Terrace Miami, FL 33138 / US For all designated states Peterson, Brian 13520 SW 136 Terrace Miami, FL 33186 / US For all designated states Peterson, Sean 13520 SW 136 Terrace Miami, FL 33186 / US [2016/49]		
Inventor(s)	01 / see applicant ... [2016/49]		
Representative(s)	Casey, Alan Michael FRKelly 27 Clyde Road Dublin D04 F838 / IE [2016/49]		
Application number, filing date	16020216.4	03.06.2016	
		[2016/49]	
Priority number, date	US201514729875	03.06.2015	Original published format: US201514729875
		[2016/49]	



Опции работы с документом

- Следующий/ предыдущий документ открывается на той же закладке, что и данный (например, на его рисунках или формуле)
- Отбор в «**Мой список патентов**» (нажатием на звёздочку)
- Для реферата, описания и формулы (если они есть) доступен перевод – нажать «**patenttranslate**». Перевод текста **с английского, немецкого и французского языков** осуществляется на 27 европейских языков из их выпадающего списка около надписи «**patenttranslate**». Обратный перевод с любого из языков из этого списка осуществляется обычно **на английский, немецкий или французский**.
- В закладке «Claims» (Формула) рядом с кнопкой «**patenttranslate**» есть кнопка «**Claims tree**» («Дерево формулы»), т.е. схема соподчиненности пунктов формулы

ФОРМУЛА (Claims)

Claims: US2015311367 (A1) — 2015-10-29

Japanese

patenttranslate powered by EPO and Google

Original claims

Claims tree

The EPO does not accept any responsibility for the accuracy of data and information originating from other authorities than the EPO; in particular, the EPO does not guarantee that they are complete, up-to-date or fit for specific purposes.

- 1. What is claimed is: 1. A solar panel arrangement, comprising:
a first solar panel having a first plurality of solar photovoltaic modules, disposed at a first plane; and
a second solar panel having a second plurality of solar photovoltaic modules, disposed at a second plane, vertically offset from the first plane.
- 18. A photovoltaic module, comprising:
a first substrate having a first plurality of photovoltaic cells, disposed at a first plane; and
a second substrate having a second plurality of photovoltaic cells, disposed at a second plane, vertically offset from the first plane.
- 25. A collection of solar arrangements, comprising:
a plurality of solar arrangements;
wherein at least one of the solar arrangements has
a first solar panel having a first plurality of solar photovoltaic modules, disposed at a first plane; and
a second solar panel having a second plurality of solar photovoltaic modules, disposed at a second plane, vertically offset from the first plane.

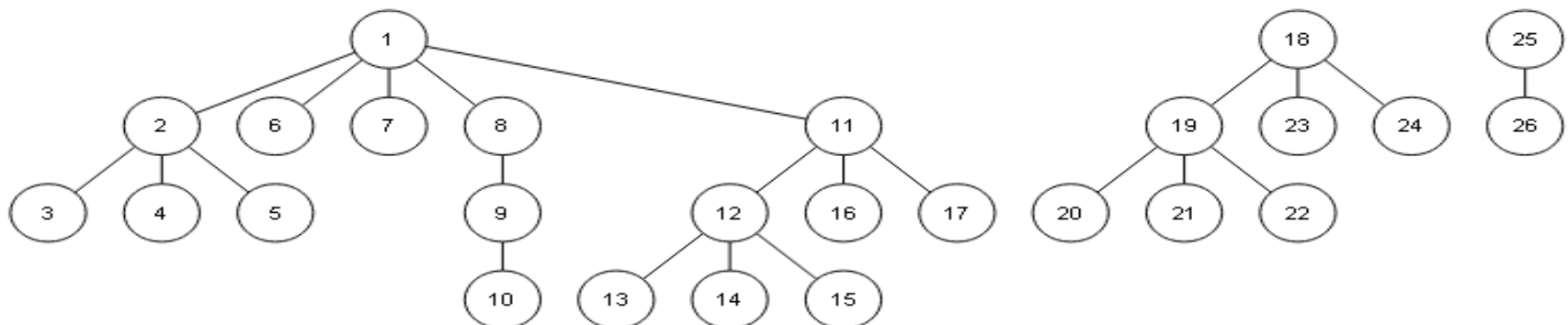



Описание изобретения

[Refine search](#) → [Results page 1](#) → [JP2005340821 \(A\)](#)

JP2005340821 (A)

[Bibliographic data](#)

[Description](#)

[Claims](#)

[Mosaics](#)

[Original document](#)

[Cited documents](#)

[Citing documents](#)

[INPADOC legal status](#)

[INPADOC patent family](#)

[Quick help](#)

- [What happens if I click on "In my patents list"?](#)
- [What happens if I click on the "EP Register" button?](#)
- [What happens if I click on the red "patent translate" button?](#)
- [Why is the description sometimes in French or German or another language altogether?](#)
- [How can I search in the text of the description?](#)
- [Can I download the complete text?](#)
- [How can I view chemical structures in the full text?](#)

Description: JP2005340821 (A) — 2005-12-08

★ [In my patents list](#) [Previous](#) ◀ 15/450 ▶ [Next](#) [EP Register](#) → [Report data error](#)

SOLAR MODULE AND MANUFACTURING METHOD FOR THE SAME

Description not available for JP2005340821 (A)

Description of corresponding document: EP1601024 (A2)

Translate this text into



Danish



patenttranslate

powered by EPO and Google

The EPO does not accept any responsibility for the accuracy of data and information originating from other authorities than the EPO; in particular, the EPO does not guarantee that they are complete, up-to-date or fit for specific purposes.

[0001] The invention relates to a solar module having a connecting element according to the preamble of claim 1 and to a method for producing a solar module according to the preamble of claim 6.

[0002] Solar modules substantially consist of a substrate, on which a plurality of lamellar or discoidal solar cells are arranged and electrically interconnected. In order to protect the solar cells against atmospheric influence the solar cells are arranged in a frame and covered by a cover layer on both sides. A transparent cover is provided on the light-sensitive side of the solar cells. The back of the solar cells is covered by a compound foil or a glass sheet.

[0003] A solar cell comprises electrical conductors, by means of which the voltage, that is generated in the solar cell during exposure to light, may be tapped. In order to conduct the current, connecting elements, by means of which an electrically conductive connection may be established between the electrical conductors of the solar cells and the connecting lines, are arranged on the housing of the solar module.

[0004] A connection box for making electrical contact with foil conductors of a solar cell is known from the patent application EP 110235. The connection box comprises an opening in the base, by means of which the foil conductors of the solar module are guided into the connection box. Connecting contacts, by means of which the foil conductors are connected, are provided in the connection box. The connecting contacts are in turn connected to connection sockets, into which connecting lines may be plugged.



Рисунки (Mosaics)

Search → Results page 1 → US2006283497 (A1)

US 2006283497 (A1)

Bibliographic data

Description

Claims

Mosaics

Original document

INPADOC legal status

Quick help

[What happens if I click on "In my patents list"?](#)

[What happens if I click on the "Register" button?](#)

[What is a mosaic?](#)

[How can I navigate through the mosaic pages?](#)

Mosaics: US 2006283497 (A1)

★ In my patents list

Previous

◀ 3 / 202 ▶

Next

→ Report data error

Print

Planar concentrating photovoltaic solar panel with individually articulating concentrator elements

Page 1/3 Drawings



Download

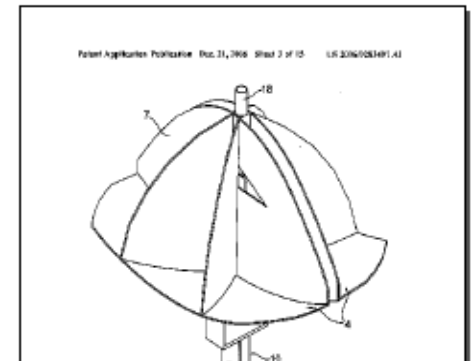
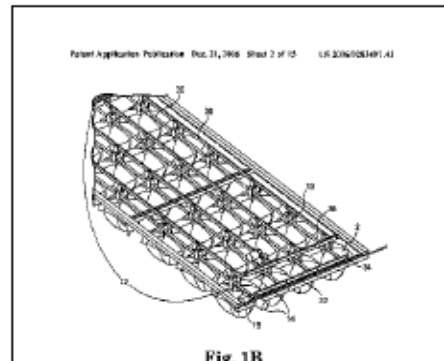
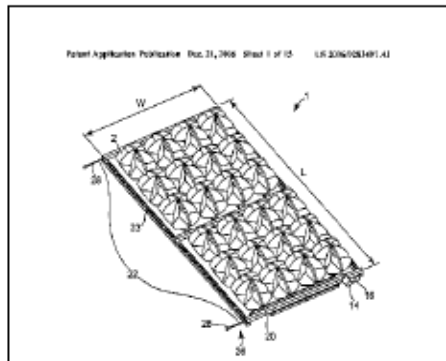



«Оригинальный документ»

- US9221516 (B1)
- Bibliographic data
- Description
- Claims
- Maximise
- Original document**
- Cited documents
- Citing documents
- INPADOC legal status
- INPADOC patent family

Quick help

- [What happens if I click on "In my patents list"?](#)
- [What happens if I click on the "Register" button?](#)
- [How can I maximise the page view?](#)
- [How can I download documents?](#)
- [Why is the Original document not available for certain documents ?](#)
- [What is Global Dossier?](#)

Original document: US9221516 (B1) — 2015-12-29

★ In my patents list Previous ◀ 10 / 240 ▶ Next Report data error



Hub motor structure

◀ ◀ Page 1/11 Abstract Bibliography ▶ ▶



Maximise



Download



US009221516B1

(12) United States Patent Song

(10) Patent No.: **US 9,221,516 B1**
(45) Date of Patent: **Dec. 29, 2015**

(54) HUB MOTOR STRUCTURE	8,419,580 B2 *	4/2013	Lo	A61G 5/04	180/65.51
(71) Applicant: MANDO CORPORATION, Pyeongtaek-si (KR)	8,795,120 B2 *	8/2014	Kim	F16H 1/28	180/65.51
(72) Inventor: Joon-Kyu Song, Seongnam-si (KR)	9,114,851 B2 *	8/2015	Schneider	B62M 6/60	B62M 6/65
(73) Assignee: MANDO CORPORATION, Gyeonggi-Do (KR)	9,139,253 B2 *	9/2015	Song	B62M 6/65	B62M 7/12
(*) Notice: Subject to any disclaimer, the term of this patent is extended or adjusted under 35 U.S.C. 154(b) by 0 days.	2005/0176542 A1 *	8/2005	Lo	B62M 7/12	475/5
(21) Appl. No.: 14/591,935	2005/0264112 A1 *	12/2005	Tanaka	B60B 27/02	310/75 C
(22) Filed: Jan. 8, 2015	2007/0187952 A1 *	8/2007	Perlo	B60L 8/00	290/1 R
(30) Foreign Application Priority Data	2011/0168511 A1 *	7/2011	Yamamoto	B62M 6/45	192/45.006
Dec. 18, 2014 (KR) 10-2014-0182938	2011/0259658 A1 *	10/2011	Huang	B60K 1/04	180/65.51
(51) Int. Cl.	2012/0083375 A1 *	4/2012	Lo	B60K 1/04	475/149
F16H 3/72 (2006.01)	2015/0191215 A1 *	7/2015	Kawakami	B62M 6/55	477/4
B62M 6/60 (2010.01)						
B62M 6/45 (2010.01)						
B62M 6/50 (2010.01)						
F16H 9/26 (2006.01)						
(52) U.S. Cl.						
CPC . B62M 6/60 (2013.01); B62M 6/45 (2013.01); B62M 6/50 (2013.01); F16H 9/26 (2013.01)						
(58) Field of Classification Search						
CPC B62M 6/60; B62M 6/50; B62M 6/45; B62M 6/65; F16H 9/26						
See application file for complete search history.						

* cited by examiner

Primary Examiner — David J Hlavka
(74) Attorney, Agent, or Firm — Ladas & Parry, LLP

(57) ABSTRACT

Disclosed is hub motor structure installed on a bicycle, the hub motor structure including a hollow shaft installed on a frame of the bicycle, a housing rotatably installed on the hollow shaft, and connected to a wheel at an outer circumferential surface thereof through spokes, a cover rotatably installed on the hollow shaft while installed on the housing, and on which a driven sprocket connected to a chain is provided to receive a pedaling force, a motor disposed in the housing and generating a rotary force to drive the wheel, a continuous variable transmission (CVT) disposed in the



Citing documents

Список документов цитирующих данную публикацию

US9221516 (B1)

Bibliographic data
Description
Claims
Mosaics
Original document
Cited documents
Citing documents
INPADOC legal status
INPADOC patent family

Citing documents: US9221516 (B1) — 2015-12-29

Select all (0/2) Compact Export (CSV | XLS) Download covers Print

2 documents citing **US9221516 (B1)**

Sort by Sort order

1. **TORQUE SENSOR AND ELECTRIC BICYCLE USING SAME**

Inventor:	Applicant:	CPC:	IPC:	Publication info:	Priority date:
★ CHEN YEN-CHI [TW] SHIH CHANG-YUAN [TW] (+1)	HON HAI PREC IND CO LTD [TW]	B62M6/50 G01B21/16 G01L3/108 (+2)	B62M6/50 G01L3/10	US2016280322 (A1) 2016-09-29 US9511818 (B2) 2016-12-06	2015-03-26

2. **VEHICLE OPERABLE BY MOTOR POWER AND BY MUSCULAR POWER**

Inventor:	Applicant:	CPC:	IPC:	Publication info:	Priority date:
★ DOMMSCH HANS-PETER [DE]	BOSCH GMBH ROBERT [DE]	B62M6/45 B62M6/55 B62M6/70 (+1)	B62M6/45 B62M6/70 B62M9/06	US2016052595 (A1) 2016-02-25	2013-04-15

Quick help

- Can I export this list?
- What happens if I click on "Download covers"?
- What are citing documents?
- Why do some documents not have any citing documents?
- What happens if I click on the star icon?

My Espacenet Help Classification search Results Advanced search Filters Popup tips [Report data error](#) [Feedback](#)

Home > Results > EP3100937A1

2 results found

List view List content Sort by

(0 patents selected) **Select the first 2 results**

1. **Communication system for a logistic chain**
EP1467295A1 • 2004-10-13 • VAN BRUMMEN JOHN [NL]
Earliest priority: 2003-04-08 • Earliest publication: 2004-10-13
The invention relates to a communication system (1) for a logistic chain (5) for objects (35) having associated unique identifiers comprising at least one communication server (2) and a plurality of communication units (3) along

2. **BICYCLE ILLUMINATION SYSTEM**
EP3100937A1 • 2016-12-07 • PETERSON BRIAN [US]
Earliest priority: 2015-06-03 • Earliest publication: 2016-12-07
A system for illuminating a bicycle having a frame comprising a plurality of

☆ EP3100937A1 **BICYCLE ILLUMINATION SYSTEM** Available in

Citations Cited documents Citing documents CCD

Publication	Priority date	Publication date	Applicants	Title	IPC	CPC	Citation origin
EP2423084A1	2010-08-30	2012-02-29	CYCLING SPORTS GROUP INC [US]	Intrinsically illuminated tubular member of a bicycle and bicycle having same	B62J6/00, B62K19/00	B62J6/00 (EP), B62J6/04 (EP), B62K19/06 (EP), B62K19/30 (EP)	SEA



Cited documents

Документы, процитированные в данной публикации

Cited documents: US9221516 (B1) — 2015-12-29

Select all (0/13) Compact Export (CSV | XLS) Download covers CCD Print

13 documents cited in relation to **US9221516 (B1)**

Sort by Sort order Sort

Patents cited in the search report

1. Apparatus and method for sensing power in a bicycle

Inventor:	Applicant:	CPC:	IPC:	Publication info:	Priority date:
★ AMBROSINA JESSE [US] PAWELKA GERHARD [US]	GRABER PRODUCTS INC [US]	CPC: B62M6/40 B62M6/45 B62M6/50 (+3)	IPC: B62M6/40 B62M6/45 B62M6/50 (+4)	US8418797 (B1) 2002-07-16	1998-03-04

2. HUB MOTOR FOR ELECTRIC VEHICLES

Inventor:	Applicant:	CPC:	IPC:	Publication info:	Priority date:
★ LO CHIU-HSIANG [TW]	LO CHIU-HSIANG [TW]	CPC: B60K1/04 B60K1/7046 B60K2001/045 (+8)	IPC: F16H57/08	US2012083376 (A1) 2012-04-05 US9348798 (B2) 2013-01-08	2010-10-01

3. ELECTRIC WHEEL FOR ELECTRIC VEHICLES

Inventor:	Applicant:	CPC:	IPC:	Publication info:	Priority date:
★ LO CHIU-HSIANG [TW]	LO CHIU-HSIANG [TW]	CPC: A61G5/04 B60K1/04 B60K1/7046 (+8)	IPC: B60K1/00 B60K7/00	US2012080934 (A1) 2012-04-05 US8419590 (B2) 2013-04-16	2010-10-01

4. DRIVE UNIT FOR ELECTRIC BICYCLE

Inventor:	Applicant:	CPC:	IPC:	Publication info:	Priority date:
★ KIM ILM YONG [KR]	MANDO CORP [KR]	CPC: B62K15/006 B62M11/15 B62M6/55 (+3)	IPC: F16H1/00 F16H1/28	US2014080651 (A1) 2014-03-20 US8795120 (B2) 2014-08-05	2012-09-19

5. DRIVE FOR A PEDAL VEHICLE, PARTICULARLY FOR CHILDREN

Inventor:	Applicant:	CPC:	IPC:	Publication info:	Priority date:
★ SCHNEIDER FRANK [DE]	SCHNEIDER GMBH & CO KG FRANZ [DE] SCHNEIDER GMBH & CO KG	CPC: B62K9/00 B62K9/02 B62M6/60	IPC: B62M6/60	US2013293996 (A1) 2013-10-10 US9114851 (B2)	2012-04-07

My Espacenet Help Classification search Results Advanced search Filters Popup tips Report data error Feedback

Home > Results > EP3100937A1

2 results found

List view: Text only | List content: All | Sort by: Relevance

(0 patents selected) Select the first 2 results

1. Communication system for a logistic chain
EP1467295A1 • 2004-10-13 • VAN BRUMMEN JOHN [NL]
Earliest priority: 2003-04-08 • Earliest publication: 2004-10-13
The invention relates to a communication system (1) for a logistic chain (5) for objects (35) having associated unique identifiers comprising at least one communication server (2) and a plurality of communication units (3) along

2. BICYCLE ILLUMINATION SYSTEM
EP3100937A1 • 2016-12-07 • PETERSON BRIAN [US]
Earliest priority: 2015-06-03 • Earliest publication: 2016-12-07
A system for illuminating a bicycle having a frame comprising a plurality of

☆ EP3100937A1 BICYCLE ILLUMINATION SYSTEM Available in

Citations

Cited documents < EP3100937A1 < Citing documents

Publication	Priority date	Publication date	Applicants	Title	IPC	CPC	Citation origin
EP2423084A1	2010-08-30	2012-02-29	CYCLING SPORTS GROUP INC [US]	Intrinsically illuminated tubular member of a bicycle and bicycle having same	B62J6/00, B62K19/00	B62J6/00 (EP), B62J6/04 (EP), B62K19/06 (EP), B62K19/30 (EP)	SEA



« Правовой статус »

US9221516 (B1)

- Bibliographic data
- Description
- Claims
- Mosaics
- Original document
- Cited documents
- Citing documents
- INPADOC legal status**
- INPADOC patent family

Quick help

- What happens if I click on "In my patents list"?
- What happens if I click on the "Register" button?
- What does "legal status" mean?
- Why is the legal status not always available?
- How might this information be useful to me?
- How reliable is this data?
- What is Global Dossier?

INPADOC legal status: US9221516 (B1) — 2015-12-29

★ In my patents list Previous 1 / 240 Report data error Print

Hub motor structure

The EPO does not accept any responsibility for the accuracy of data and information originating from other authorities than the EPO; in particular, the EPO does not guarantee that they are complete, up-to-date or fit for specific purposes.

Legal status of US9221516 (B1) 2015-12-29:

US	F	201514591935 A (Patent of invention)
Event date :	2015/01/08	
Event code :	AS	
Code Expl.:	ASSIGNMENT	
NEW OWNER :	MANDO CORPORATION, KOREA, REPUBLIC OF	
EFFECTIVE DATE :	20141224	
FURTHER INFORMATION :	ASSIGNMENT OF ASSIGNORS INTEREST;ASSIGNOR:SONG, JOON-KYU;REEL/FRAME:034664/0196	

My Espacenet Help Classification search Results Advanced search Filters Popup tips Report data error Feedback

Home > Results > US4865403A

354 373 results found

List view List content Sort by

Text only All Relevance

(0 patents selected) Select the first 60 results

...The invention relates to the field of teaching supplies, in particular to a folding desk. The folding desk comprises a desk body and a folding back plate, the desk body is connected with the folding back plate through a

34. **DESK PLATE DISPLAY TYPE DESK DEVICE**
 JPH04300502A • 1992-10-23 • SHIMADZU CORP
Earliest priority: 1991-03-29 • Earliest publication: 1992-10-23
 ...PURPOSE:To offer the desk plate display type desk device by which a word processor work can be executed easily... is installed so as to be

☆ US4865403A Folding standup desk Available in

Legal events

The EPO does not accept responsibility for the accuracy of data originating from authorities other than the EPO, nor does it guarantee that such data is complete, up-to-date or fit for specific purposes.

Event indicator	Category	Event description	Countries	Event date	Effective date	Details
US CC	Q: Document publication	CERTIFICATE OF CORRECTION		1990-11-06		
US FPAY	U: Payment	FEE PAYMENT		1993-03-03		Fee payment Year: 4



INPADOC patent family Патентное семейство

US9221516 (B1)

- Bibliographic data
- Description
- Claims
- Mosaics
- Original document
- Cited documents
- Citing documents
- INPADOC legal status
- INPADOC patent family**

Quick help

- Can I export this list?
- What happens if I click on "Download covers"?
- Can I sort the list?
- What happens if I click on the star icon?
- What is a patent family?
- What happens if I tick the "show citations" box?
- What is an INPADOC patent family?
- Are all the documents in an INPADOC family equivalents?
- Why is the same document published several times in the same country?

Family list: US9221516 (B1) — 2015-12-29

Select all (0/4) Compact

4 application(s) for: **US9221516 (B1)**

Sort by: Sort order: show citations

Hub motor structure	Inventor:	Applicant:	CPC:	IPC:	Publication info:	Priority date:
1. Hub motor structure	★ SONG JOON-KYU [KR]	MANDO CORP [KR]	B62M11/16 B62M6/45 B62M6/50 (+2)	B62M6/45 B62M6/50 B62M6/60 (+2)	US9221516 (B1) 2015-12-29 Global Dossier	2014-12-18
2. Hub motor structure	★ SONG JOON-KYU	MANDO CORP	B62M11/16 B62M6/45 B62M6/50 (+2)	B62M7/12	CN105836035 (A) 2016-08-10 Global Dossier	2014-12-18
3. Hub motor structure	★ SONG JOON-KYU [KR]	MANDO CORP [KR]	B62M11/16 B62M6/45 B62M6/50 (+2)	B62M11/16 B62M6/65 B62M7/12	EP3034387 (A1) 2016-06-22 Global Dossier	2014-12-18
4. HUB MOTOR STRUCTURE	★ SONG JOON KYU [KR]	MANDO CORP [KR]	B62M11/16 B62M25/02 B62M6/40 B62M6/50 (+8)	B62M25/02 B62M6/40 B62M6/50 (+2)	KR20160074765 (A) 2016-06-29 Global Dossier	2014-12-18

My Espacenet Help Classification search Results Advanced search Filters Popup tips Report data error Feedback

Home > Results > US4865403A

354 373 results found

List view: Text only | List content: All | Sort by: Relevance

(0 patents selected) Select the first 60 results

...The invention relates to the field of teaching supplies, in particular to a folding desk. The folding desk comprises a desk body and a folding back plate, the desk body is connected with the folding back plate through a

34. **DESK PLATE DISPLAY TYPE DESK DEVICE**
JPH04300502A • 1992-10-23 • SHIMADZU CORP
Earliest priority: 1991-03-29 • Earliest publication: 1992-10-23
...PURPOSE: To offer the desk plate display type desk device by which a word processor work can be executed easily... is installed so as to be tiltable on the desk, a tilting desk plate 1 for forming the upper face P of

35. **THE TURN DOWN DESK**

☆ US4865403A Folding standup desk Available in

Patent family

Simple family **INPADOC family** Latest legal events CCD ↗

RSS: Family dossier 4 applications, 5 publications

Publication	Application number	Family	Title	Publication date	Applicants	CP
AT64281T	AT88103546T	Simple	ZUSAMMENLEGBARES STEHPULT.	1991-06-15	STEINHILBER HELMUT	A4 (EF) A4 (EF) A4 (EF)

Стартовая страница Espacenet new

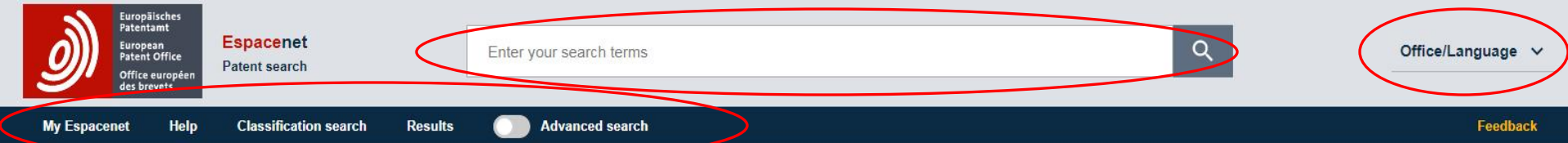

Espacenet: free access to over 110 million patent documents





Поисковые массивы в Espasenet new

Worldwide объединена с полнотекстовыми
коллекциями EN, DE, FR.

Поиск патентных данных ведётся в них одновременно.



Постоянное горизонтальное меню new

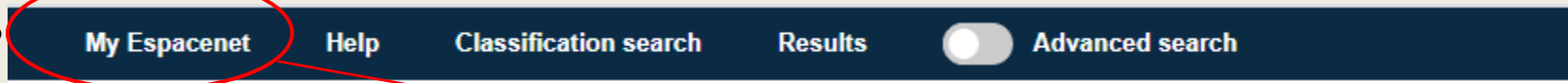

- My patents
- My queries
- My settings

- Help
- Classification search
- Results
- Advanced search

Espacenet
 Patent search

Enter your search terms

My Espacenet Help Classification search Results Popup tips

[My patents](#) [My queries](#) [My settings](#)

My Patents

2 results found

List view: Text only List content: All

(0 patents selected) **Select the first 2 results**

1. **Bicycle computer** allowing user to input desired data
 US2004095362A1 • 2004-05-20 • CATEYE CO LTD [US]
Earliest priority: 1999-08-25 • Earliest publication: 2001-03-06
 Run data of a **bicycle** and personal information of a user are input in a **bicycle computer**. A display part of the **bicycle computer** has upper and lower lines, which can be set to desired display sizes. A screen unknown to



Help (Помощь)

My Espacenet

Help

Classification search

Results



Advanced search

Glossary

Applicant

Application number

Application

Bibliographic data

Category

CCD

Citation origin

Citations

Cited documents

Citing documents

Claims

Classifications

Country codes

CPC

C-sets

Description

Drawings

Espacenet offers you a range of user support options

Glossary

Definitions of the terms used in Espacenet and more generally in the world of patent information.

Changes in Espacenet

A document explaining the **major changes** compared to classic Espacenet.

Pocket guide

A **guide** to the essentials of searching and filtering.

Tooltips

Short messages to guide you in your interaction with Espacenet. They appear for some elements of the user interface when you hover the mouse over them.

Popup tips

Brief explanations in context. Turn on popup tips using the toggle on the main navigation bar. Now you'll see a question-mark icon next to certain interface items. To open a popup tip, simply select the icon next to the item in question.

Espacenet forum

A place to post your opinions, ask questions and share information with our experts and user community: **Espacenet forum**.

Contact us

If you have any comments or suggestions, please write to us.



Advanced search (Расширенный поиск) new

Advanced search **всегда** синхронизирован со Smart search.

The screenshot shows the Espacenet Patent search interface. At the top, the search bar contains the query "ctxt all 'desk'", which is circled in red. Below the search bar, the "Advanced search" toggle is turned on and also circled in red. The main search area shows a query structure with "AND" and "+ Field" buttons circled in red. The first search group is titled "Title, abstract or claims" and contains a search term "desk". The second search group is titled "Title or abstract" and is currently empty. Below the search groups, there are filter sections for "Publication date", "Inventors", and "IPC", each with a dropdown menu and a search input field.



Логические операторы в Espasenet new

Все поля связаны оператором **AND** по умолчанию

Можно при необходимости переключиться на **OR** или **NOT**



Логические операторы внутри поисковых полей Esprascenet new

- **Нельзя** использовать логические операторы **AND, OR, NOT** внутри полей.
- Можно использовать операторы:
ANY = OR
ALL = AND
PROXIMITY
=



Список результатов new

Search results for "desk" on Espacenet. The search bar contains "desk". The navigation menu includes "My Espacenet", "Help", "Classification search", "Results", "Advanced search", "Filters", and "Popup tips". The "Results" tab is active. The search results show "354 198 results found". The first result is "1. PORTABLE ADJUSTABLE DESK SYSTEM" with patent number US10117510B2 and publication date 2017-09-07. The second result is "2. Desk, in Particular Pupil Desk" with patent number US2008105173A1 and publication date 2008-05-08.

Search results for "desk" on Espacenet with advanced search options. The search bar contains "desk". The navigation menu includes "My Espacenet", "Help", "Classification search", "Results", "Advanced search", "Filters", and "Popup tips". The "Advanced search", "Filters", and "Popup tips" options are checked. The search results show "354 198 results found". The first result is "1. PORTABLE ADJUSTABLE DESK SYSTEM" with patent number US10117510B2 and publication date 2017-09-07. The second result is "2. Desk, in Particular Pupil Desk" with patent number US2008105173A1 and publication date 2008-05-08.



Filters (Фильтры)

Espacenet Patent search

table

My Espacenet Help Classification search Results **Advanced search** **Filters** Popup tips

Home > Results

Query language: en / de / fr Filters: Priority date: 1837-01-01 — 2020-12-31 Clear

Family **Publication**

10 029 366 results found

List view: Text only List content: All Sort by: Relevance

(0 patents selected) **Select the first 20 results**

1. No title available
GR69882B • 1982-07-20 • BAT CIGARETTENFAB GMBH
Earliest priority: 1979-01-26 • Earliest publication: 1980-07-31
No abstract available

2. Appareil de commande à moteur électrique, par exem...
CH292175A • 1953-07-31 • AMERICAN SAFETY TABLE C...
Earliest priority: 1950-06-08 • Earliest publication: 1953-07-31
No abstract available

3. Appareil à presser les cols et autres articles d'habillem...
CH292775A • 1953-08-31 • AMERICAN SAFETY TABLE C...
Earliest priority: 1950-06-09 • Earliest publication: 1953-08-31
No abstract available

4. Folding balcony
US5528993A • 1996-06-25 • VINCOS BALCONY TABLE IN...
Earliest priority: 1993-08-18 • Earliest publication: 1995-02-19

Countries (publication) Languages (publication) Publication date (publication)

Family

Priority date IPC main groups IPC subgroups CPC main groups CPC subgroups CPC assigning offices Applicants Inventors



Filters (Фильтры)

The screenshot shows the Espacenet patent search interface. At the top, the search bar contains the word "table". The navigation menu includes "My Espacenet", "Help", "Classification search", "Results", "Advanced search", "Filters", and "Popup tips". The "Filters" option is highlighted with a green circle. Below the navigation, the search language is set to "en / de / fr" and the priority date range is "1837-01-01 — 2020-12-31". A filter for "Countries (publication)" is active, showing a horizontal bar chart with the following data:

Country	Count
JP	~10,000
US	~8,000
CN	~6,000
WO	~2,000
KR	~1,500
EP	~1,500
CA	~1,000
AU	~1,000
GR	~1,000

At the bottom of the filter section, the "Apply", "Exclude", and "+ query" buttons are circled in red. The search results section displays "10 029 366 results found" and lists the first four results:

- (0 patents selected) **Select the first 20 results**
- 1. No title available
GR69882B • 1982-07-20 • BAT CIGARETTENFAB GMBH
Earliest priority: 1979-01-26 • Earliest publication: 1980-07-31
No abstract available
- 2. Appareil de commande à moteur électrique, par exem...
CH292175A • 1953-07-31 • AMERICAN SAFETY TABLE C...
Earliest priority: 1950-06-08 • Earliest publication: 1953-07-31
No abstract available
- 3. Appareil à presser les cols et autres articles d'habillem...
CH292775A • 1953-08-31 • AMERICAN SAFETY TABLE C...
Earliest priority: 1950-06-09 • Earliest publication: 1953-08-31
No abstract available
- 4. Folding balcony



Popup tips (Подсказки)

 **Espacenet**
Patent search



table

My Espacenet Help Classification search Results Advanced search Filters **Popup tips**

Home > Results

Query language: en / de / fr Filters: Priority date: 1837-01-01 — 2020-12-31 Clear

10 029 366 results found[?]

List view: Text only List content: All Sort by: Relevance  

(0 patents selected) **Select the first 20**

[?] 1. No title available
GR69882B [?] • 1982-07-20 [?] • E
Earliest priority: 1979-01-26 [?] • Earli
No abstract available

2. Appareil de commande à moteur électrique, par exem...
CH292175A • 1953-07-31 • AMERICAN SAFETY **TABLE** C...
Earliest priority: 1950-06-08 • Earliest publication: 1953-07-31
No abstract available

Sort by

Sort by rank to display the most relevant documents at the top of the list, or sort in ascending or descending order according to publication or priority date.



Работа со списком результатов new

- Всегда получаем точное число найденных документов (при наведении курсора на это число также отображается точное количество отдельных публикаций, соответствующих критериям поиска);
- В списке найденных документов отображается до **2000** результатов;
- Только первые **500** результатов можно загружать в формате **xlsx** или **csv**. Вы можете загрузить только первые **100** титульных страниц в формате **pdf**.
- Для последующего анализа в «**My patent**» можно отобрать документы (нажатием на звёздочку в списке или выбрав в трехточечном меню в верхней части списка результатов **Add selection to My patents**);
- Возможны варианты просмотра списка документов (только текст; текст и чертежи; компактный список; только чертежи);
- Автоматическое ранжирование найденных документов по релевантности.



Работа с документом new

My Espacenet Help Classification search Results **Advanced search** Filters Popup tips Report data error Feedback

Home > Results > US4865403A

354 373 results found

List view List content Sort by
Text only All Relevance

(0 patents selected) Select the first 60 results

...The invention relates to the field of teaching supplies, in particular a folding desk. The folding desk comprises a desk body and a folding back plate, the desk body is connected with the folding back plate through a...

34. **DESK PLATE DISPLAY TYPE DESK DEVICE**
JPH04300502A • 1992-10-23 • SHIMADZU CORP
Earliest priority: 1991-03-29 • Earliest publication: 1992-10-23
...PURPOSE: To offer the desk plate display type desk device by which word processor work can be executed easily... is installed so as to be tiltable on the desk, a tilting desk plate 1 for forming the upper face P of

35. **THE TURN DOWN DESK**
KR20110054200A • 2011-05-25 • KIM TAE WOO [KR]

☆ US4865403A Folding standup desk

Available in Patent Translate

Bibliographic data Bibliographic data

Description
Claims
Drawings
Original document
Citations
Legal events
Patent family

STEINHILBER HELMUT [CH] +
STEINHILBER HELMUT [CH] +

A47B17/03; A47B19/08; A47B46/00; (IPC1-7):
A47B17/00;

CPC A47B17/03 (EP); A47B19/08 (EP);
A47B46/00 (EP);

Front-page drawing from US4865403A

English ^

EP0284833B1

US4865403A

French v

German v

My Espacenet Help Classification search Results **Advanced search** Filters Popup tips Report data error Feedback

Home > Results > US4865403A

354 373 results found

List view List content Sort by
Text only All Relevance

(0 patents selected) Select the first 60 results

...The invention relates to the field of teaching supplies, in particular to a folding desk. The folding desk comprises a desk body and a folding back plate, the desk body is connected with the folding back plate through a...

34. **DESK PLATE DISPLAY TYPE DESK DEVICE**
JPH04300502A • 1992-10-23 • SHIMADZU CORP
Earliest priority: 1991-03-29 • Earliest publication: 1992-10-23
...PURPOSE: To offer the desk plate display type desk device by which word processor work can be executed easily... is installed so as to be tiltable on the desk, a tilting desk plate 1 for forming the upper face P of

☆ US4865403A Folding standup desk

Available in Patent Translate

Description

The EPO does not accept responsibility for the accuracy of data originating from authorities other than the EPO, nor does it guarantee that such data is complete, up-to-date or fit for specific purposes.

The invention relates to a folding standup desk.

Prolonged seated activity at a writing desk is frequently perceived as uncomfortable and is also especially disadvantageous for health reasons. It is therefore advantageous to interrupt the seated activity at intervals by standing activity at a standup desk. A standup desk

U.S. Patent Sep. 12, 1992 65,403

Menu

Download v

Share this patent v



Работа с документом new

☆ WO9705935A1 **TABLE GAME CONTROL SYSTEM** Available in ▾

Citations ▾

Cited documents < WO9705935A1 ▾ < Citing documents CCI

Publication	Priority date	Publication date	Applicants	Title	IPC	CPC	Citation origin
US4531187A	1982-10-21	1985-07-23	UHLAND JOSEPH C	Game monitoring apparatus	G06F19/00, G07F17/32	G07F17/32 (EP), G07F17/3232 (EP), G07F17/3234 (EP), A63F2009/2435 (EP)	ISR
US4755941A	1985-09-06	1988-07-05	BACCHI LORENZO [GB]	System for monitoring the	G07D9/00, G07F17/32, G07F9/08	G07D9/002 (EP), G07F17/32	ISR

☆ WO9705935A1 **TABLE GAME CONTROL SYSTEM** Available in ▾

Legal events ▾

The EPO does not accept responsibility for the accuracy of data originating from authorities other than the EPO, nor does it guarantee that such data is complete, up to date or fit for specific purposes.

Event indicator	Category	Event description	Countries	Event date	Effective date	Details
WO AK	W: Other	DESIGNATED STATES		1997-02-20		Reference document Kind: A1
WO AL	W: Other	DESIGNATED COUNTRIES FOR REGIONAL PATENTS		1997-02-20		Reference document Kind: A1



Smart search (УМНЫЙ ПОИСК)

- Ввод запроса - в одно поисковое окно
- Запросы могут вводиться как с кодами (идентификаторами) полей, так и без них.
- Основные типы полей: rd (дата публикации),
cl (классификация),
num (номер),
ia (изобретатель и заявитель),
txt (4 текстовых поля)
- Поисковые **поля** можно соединять оператором OR (но по умолчанию, т.е. без ввода оператора, используется AND)
- Каждый тип поля (кроме даты публикации) подразделяется ещё на несколько более конкретных полей.



Алгоритм «угадывания»

ПОИСКОВОГО ПОЛЯ

Введено:	Описание	Код поля
<ul style="list-style-type: none">• yyyymmdd OR yyyu OR yyyymm• "dd/mm/yyyy"	Если введенная информация соответствует одному из этих форматов, то это – дата.	pd (дата публикации)
<ul style="list-style-type: none">• H01M5/12• a• B03	Если введенная информация соответствует формату записи классификационного индекса, то это – классификация	cl (классификация)
<ul style="list-style-type: none">• EP• FR3• MXPA01007454• EP1000000A1• FI63764B	Если введенная информация состоит из двух (или трех, или четырех) букв, за которыми идет ряд цифр, за которым может быть одна буква или цифра, то это – номер.	num (номер)
<ul style="list-style-type: none">• Apple• Microsoft• John	Если введенная информация начинается с заглавной буквы и затем содержит только строчные буквы, то это – имена или названия.	ia (изобретатель и заявитель)
<ul style="list-style-type: none">• motor• engine	Если введенная информация не соответствует ни одному вышеприведенному условию, то это – текст (название, реферат, изобретатель и заявитель).	txt (код по умолчанию)



Поля в Smart search

Код поля	Описание	Примеры
in	изобретатель	in=smith
pa	заявитель	pa=Siemens
ti	название	ti="mouse trap"
ab	реферат	ab="mouse trap"
pr	номер приоритетной заявки	pr=ep20050104792
pn	номер публикации	pn=ep1000000
ap	номер заявки	ap=jp19890234567
pd	дата публикации	pd=20080107 OR pd="07/01/2008" OR pd=07/01/2008
ct	цитата/ цитируемый документ	ct=ep1000000
ipc	международная классификация (все версии МПК, текущая и предыдущие)	ipc=A63B49/08
cpc	совместная патентная классификация	cpc="A61K31/13"
cpcс	комбинационные наборы в CPC	cpcс="C08F8/30", cpcс="C08F297/02"
cl	классификация (ipc и cpc)	cl=C10J3
desc	поиск в описании	desc=lens
claims	поиск в формуле	claims=laser
ftxt	поиск в описании и формуле («полный текст»)	ftxt=microscope
extftxt	поиск в названии, реферате, описании и формуле	extftxt=nanoparticle
ia	изобретатель и заявитель	ia=Apple или ia="Ries klaus"
ta	название и реферат	ta="laser printer"
txt	название, реферат, изобретатель и заявитель	txt="microscope lens"
num	номер публикации, заявки или приоритетной заявки	num=ep1000000



Поля в Smart search new

Field identifier in Smart search		Description / Equivalent search field in Advanced search	Example
in new Espacenet	in classic Espacenet		
nftxt	-	All text fields or names	nftxt="extreme uv lithography"
ntxt	<i>txt</i>	Title, abstract or names	ntxt=microscope lens
ti	<i>ti</i>	Title	ti="mouse trap"
ab	<i>ab</i>	Abstract	ab="mouse trap"
desc	<i>desc</i>	Description	desc=lens
claims	<i>claims</i>	Claims	claims=laser
ta	<i>ta</i>	Title or abstract	ta="laser printer"
ctxt	-	Title, abstract or claims	ctxt=milking ctxt=robots
ftxt	<i>extftxt</i>	All text fields (title, abstract, description or claims)	ftxt=nanoparticles
in	<i>in</i>	Inventors	in=smith
pa	<i>pa</i>	Applicants	pa=siemens
ia	<i>ia</i>	Inventors or applicants	ia=apple OR ia="ries klaus"
pd ¹	<i>pd</i>	Publication date	pd=20180107
pr	<i>pr</i>	Priority number	pr=ep20050104792
pn	<i>pn</i>	Publication number	pn=ep1000000 pn=EPB1 ²
ap	<i>ap</i>	Application number	ap=jp19890234567
num	<i>num</i>	Numbers	num=ep1000000
ipc	<i>ipc</i>	IPC	ipc=A63B49/08
cpc	<i>cpc</i>	CPC	cpc="A61K31/13"
cpcc	<i>cpcc</i>	CPC C-sets	cpcc="C08F297/02"
cl	<i>cl</i>	IPC or CPC	cl=C10J3
ct	<i>ct</i>	Cited documents	ct=ep1000000



Запись запросов в Smart search

- ! Если внутри какого-либо поля в Smart search нужно найти несколько терминов, они должны быть заключены в кавычки
- Операторы **AND, OR, NOT**. Ни один не имеет преимуществ по порядку выполнения. Выполняется – слева направо.

Операторы сравнения

- **=** (равно); Это – безусловное отношение, например:
pa=Siemens или **ti="optical fiber"**
- **all** (все); Все введенные термины будут найдены в заданном поле, но их порядок в документе может не соответствовать порядку их записи в запросе:
Пример: **ti all "paint brush hair"**
- **any** (любой); Будут найдены документы, содержащие в данном поле по меньшей мере один из заданных терминов.
Пример: **ti any "motor engine"**

Операторы для дат публикации

- **within** Например: **pd within "2005 2006"** или **pd = "2005, 2006"** или **pd =2005 2006**
- **<=** Например: **pd <=2005** (дата публ. равна или более ранняя, чем 2005)
- **>=** Например: **pd >=2007** (дата публ. равна или более поздняя, чем 2007)
- **pd=20060104,20060304** (с 4 января по 4 марта 2006 включительно)



Операторы близости в Smart search

(proximity – близость)

- **T1 prox/distance<n T2** Пример: **mouse prox/distance<3 trap**
(**мышь prox/distance<3 ловушка**)

Система найдет патенты, где слова **mouse** и **trap** находятся в текстовых полях (код поля txt) на расстоянии не более 3 (трёх) слов между ними в заданном порядке (в порядке написания).

- **T1 prox/unit=sentence T2** Пример: **mouse prox/unit=sentence trap**

Система найдет патенты, где слова **mouse** и **trap** встречаются в текстовых полях в одном и том же предложении.

- **T1 prox/unit=paragraph T2** Пример: **mouse prox/unit=paragraph trap**

Система найдет патенты, где слова **mouse** и **trap** встречаются в одном и том же параграфе (абзаце) в текстовых полях.

- **T1 prox/ordered T2** Пример: **ia=Apple prox/ordered ia=Corp**

Система найдет документы, содержащие в указанном порядке (в заданном поле) Apple Corp, а не Corp Apple.



Classification Search (Поиск в CPC)

- CPC базируется на МПК, но в ней – втрое больше рубрик
- Дополнительный раздел Y

Cooperative Patent Classification

Search for

View section **Index** A B C D E F G H Y

Quick help

- What is the Cooperative Patent Classification system?
- How do I enter classification symbols?
- What do the different buttons mean?
- Can I retrieve a classification using keywords?
- Can I start a new search using the classifications listed?
- Where can I view the description of a particular CPC class?
- What is the meaning of the stars in front of the classifications found?
- What does the text in brackets mean?

Symbol	Classification and description
<input type="checkbox"/> A	HUMAN NECESSITIES
<input type="checkbox"/> B	PERFORMING OPERATIONS; TRANSPORTING
<input type="checkbox"/> C	CHEMISTRY; METALLURGY
<input type="checkbox"/> D	TEXTILES; PAPER
<input type="checkbox"/> E	FIXED CONSTRUCTIONS
<input type="checkbox"/> F	MECHANICAL ENGINEERING; LIGHTING; HEATING; WEAPONS; BLASTING ENGINES OR PUMPS
<input type="checkbox"/> G	PHYSICS
<input type="checkbox"/> H	ELECTRICITY
<input type="checkbox"/> Y	GENERAL TAGGING OF NEW TECHNOLOGICAL DEVELOPMENTS; GENERAL TAGGING OF CROSS-SECTIONAL TECHNOLOGIES SPANNING OVER SEVERAL SECTIONS OF THE IPC; TECHNICAL SUBJECTS COVERED BY FORMER USPC CROSS-REFERENCE ART COLLECTIONS [XRACS] AND DIGESTS

Selected classifications
nothing selected

My Espacenet Help **Classification search** Results

Classification search

Enter a keyword or a classification symbol

Index A B C D E F G H Y

« Previous Next »

Selected classifications

Classification symbol	Title and description
-----------------------	-----------------------



Варианты использования поиска в СРС

- Выбор подходящей рубрики последовательным просмотром нужных раздела, класса, подкласса и т.д.
- Поиск определения содержания рубрики по известному её индексу, который вводится в то же окошко
- Поиск подходящих рубрик СРС по ключевым словам: слова вводятся в верхнее поисковое окошко “Search for **a keyword or classification symbol**” (Поиск по ключевому слову или индексу классификации).

Вид CPC в Espacenet

Smart search
Advanced search
Classification search

Quick help

- [What is the Cooperative Patent Classification system?](#)
- [How do I enter classification symbols?](#)
- [What do the different buttons mean?](#)
- [Can I retrieve a classification using keywords?](#)
- [Can I start a new search using the classifications listed?](#)
- [Where can I view the description of a particular CPC class?](#)
- [What is the meaning of the stars in front of the classifications found?](#)
- [What does the text in brackets mean?](#)

Selected classifications

nothing selected

Find patents

Copy to search form

Cooperative Patent Classification

Search for

View section | [Index](#) | [A](#) | [B](#) | [C](#) | [D](#) | [E](#) | [F](#) | [G](#) | **[H](#)** | [Y](#)











Navigation icons: back, forward, home, search, CPC, expand, refresh, zoom in, zoom out, 2000

[« H04N5/00](#) [H04N9/00 »](#)

Symbol	Classification and description	
<input type="checkbox"/> H	ELECTRICITY	S i
<input type="checkbox"/> H04	ELECTRIC COMMUNICATION TECHNIQUE	i
<input type="checkbox"/> H04N	PICTORIAL COMMUNICATION, e.g. TELEVISION (measuring, testing G01 ; systems for autographic writing, e.g. writing telegraphy, which involve following an outline G08C 21/00 ; information storage based on relative movement between record carrier and transducer G11B ; coding, decoding or code conversion, in general H03M ; broadcast distribution or the recording of use made thereof H04H)	S D i ↓
<input type="checkbox"/> H04N 1/00	Scanning, transmission or reproduction of documents or the like, e.g. facsimile transmission; Details thereof ({ recording arrangements for measuring instruments G01D ; sensing record carriers G06K 7/00 ; character or pattern recognition G06K 9/00 ; mosaic printer telegraph systems H04L 21/00 }	D
<input type="checkbox"/> H04N 3/00	Scanning details of television systems	D
<input type="checkbox"/> H04N 5/00	Details of television systems (scanning details or combination thereof with generation of supply voltages H04N 3/00 ; specially adapted for colour television H04N 9/00 ; { servers specially adapted for the distribution of content H04N 21/20 ; client devices specially adapted for the reception of or interaction with content H04N 21/40 }	D i
<input type="checkbox"/> H04N 7/00	Television systems (details H04N 3/00 , H04N 5/00 ; methods or arrangements, for coding, decoding, compressing or decompressing digital video signals H04N 19/00 ; selective content distribution H04N 21/00)	D
<input type="checkbox"/> H04N 7/002	• { Special television systems not provided for by H04N 7/007 to H04N 7/18 } ({ still pictures via a television channel H04N 1/00098 }	D
<input type="checkbox"/> H04N 7/005	• {using at least one opto-electrical conversion device}	
<input type="checkbox"/> H04N 7/007	• {Systems with supplementary picture signal insertion during a portion of the active part of a television signal, e.g. during top and bottom lines in a HDTV letter-box system}	D
<input type="checkbox"/> H04N 7/01	• Conversion of standards {involving analogue television standards or digital television standards processed at pixel level} ({ video transcoding H04N 19/40 ; image scaling in general G06T 3/40 ; adaptive insertion signals to the display format of the display terminal	D



Линейка форматирования представления схемы

-   - расположение индексов рубрик слева или справа от их определений
-   - иерархия «деревом» или точками
-   - отображение предупреждений и/или примечаний
-  - выделение зеленым цветом отличий от МПК
-  - отображение даты введения рубрики
-  - отображение отсылок к другим рубрикам
-   - выключение/включение отображения индексировующих кодов

Включение отображенных рубрик в поиск

- Отметить нужную (нужные) рубрики «галочкой»

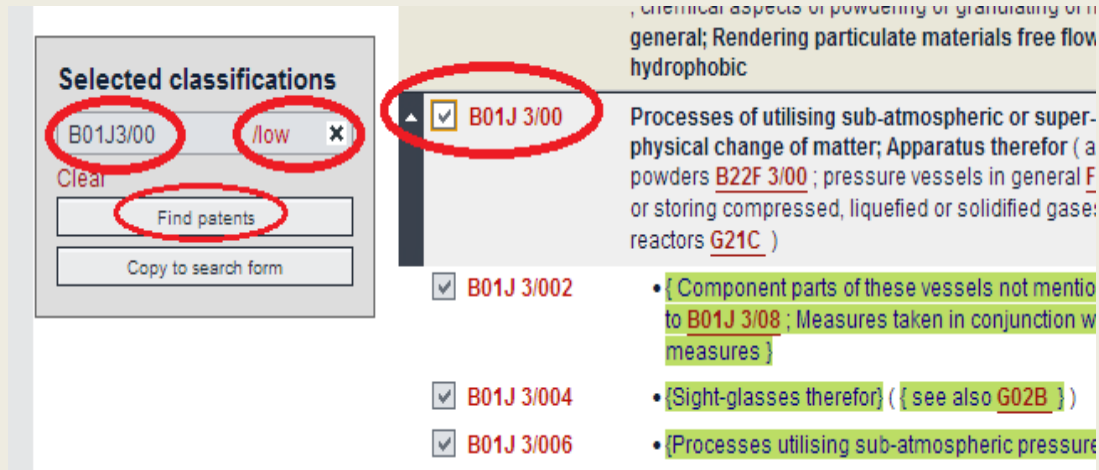

The screenshot shows a search interface with a 'Selected classifications' panel on the left and a list of search results on the right. In the 'Selected classifications' panel, the classification 'B01J3/00' and the operator '/low' are circled in red. Below this panel are buttons for 'Clear', 'Find patents', and 'Copy to search form'. In the search results, the classification 'B01J 3/00' is checked with a red box. The description for 'B01J 3/00' includes text like 'Processes of utilising sub-atmospheric or super-physical change of matter; Apparatus therefor'. Other results like 'B01J 3/002', 'B01J 3/004', and 'B01J 3/006' are also listed with their respective descriptions.

- Оставить или убрать оператор **/low**
- Провести поиск сразу или скопировать в Advanced search для соединения с другими терминами



Результат поиска в CPC по ключевым словам

Cooperative Patent Classification

Search for

View section | [Index](#) | [A](#) | [B](#) | [C](#) | [D](#) | [E](#) | [F](#) | [G](#) | [H](#) | [Y](#)

« H04N5/00 H04N9/00 »

Symbol	Classification and description
▼ ★★ ★★	<input type="checkbox"/> H04M 1/00 Substation equipment, e.g. for use by subscribers; Analogous equipment at exchanges (...)
▼ ★★ ★★ ★★	<input type="checkbox"/> G06Q 30/00 Commerce, e.g. shopping or e-commerce
▼ ★★ ★★ ★★ ★★	<input type="checkbox"/> G06Q 20/00 Payment architectures, schemes or protocols (...)
▼ ★★ ★★ ★★ ★★	<input type="checkbox"/> H04W 4/00 {Mobile application} services or facilities specially adapted for wireless communication networks (...)
▼ ★★ ★★ ★★ ★★	<input type="checkbox"/> G06F 3/00 Input arrangements for transferring data to be processed into a form capable of being handled by the computer; Output arrangements for transferring data from processing unit to output unit, e.g. interface arrangements (...)
▼ ★★ ★★ ★★ ★★	<input type="checkbox"/> H04L 63/00 {Network architectures or network communication protocols for network security} (...)
▼ ★★ ★★ ★★ ★★	<input type="checkbox"/> H04M 3/00 Automatic or semi-automatic exchanges (...)
▼ ★★ ★★ ★★ ★★	<input type="checkbox"/> G06F 17/00 Digital computing or data processing equipment or methods, specially adapted for specific functions
▼ ★★ ★★ ★★ ★★	<input type="checkbox"/> H04W 8/00 Network data management
▼ ★★ ★★ ★★ ★★	<input type="checkbox"/> H04L 51/00 {Arrangements for user-to-user messaging in packet-switching networks, e.g. e-mail or instant messages}



Спасибо за внимание!